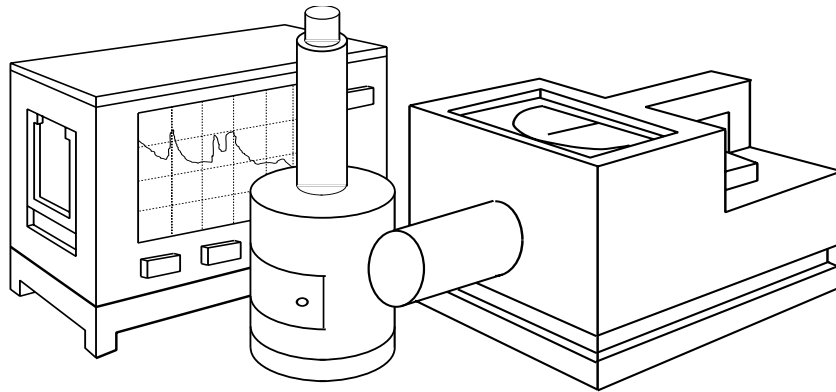


**TECHNICAL UNIVERSITY  
DRESDEN**

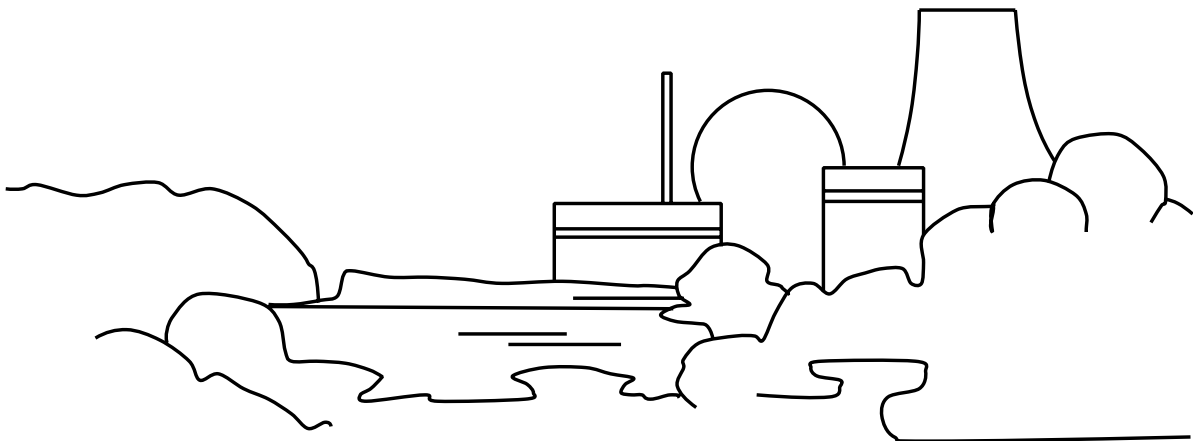
Institute of Power Engineering  
Training Reactor



**Reactor Training Course**

**Experiment**

**"Adjoint Flux Function"**



## **Instruction**

### **Experiment "Adjoint Flux Function"**

---

#### **Content:**

1. . . . Motivation
2. . . . Tasks
3. . . . Introduction
4. . . . Instructions Concerning the Experiment
5. . . . Instructions Concerning the Protocol
6. . . . Questions to Answer

#### **Appendix 1:** Physical Background

#### **Appendix 2:** Application of Perturbation Theory to Experiments at the AKR (One-Group Theory)

#### **Appendix 3:** Application of Perturbation Theory to Experiments at the AKR (Two-Group Theory)

#### **Appendix 4:** Protocol forms

#### **Figures:**

Fig. 1: Experimental setup

Fig. 2: Normalised BESSEL functions  $I_0$  and  $I_1$  and its squares for the radial dimensions of the AKR

Fig. 3a: Radial distribution of the neutron fluxes and of the adjoint fluxes at the AKR

Fig. 3b: Radial distribution of  $\frac{\partial}{\partial r} \Phi_2$  and  $\frac{\partial}{\partial r} \Phi_2^+$  at the AKR

Fig. 4: Typical shape of an absorber characteristic in the AKR

Fig. 5: Typical shape of a scatterer characteristic in the AKR

(issued: March 2015)

## 1. Motivation

For the safe operation of a nuclear reactor it is necessary to know all effects that result from changes of both, the material composition and the geometry of the reactor core.

The influence of such changes on the reactor-physical behaviour can be described globally by the resulting reactivity changes.

By measuring reactivity characteristics for samples made from different materials the qualitative and quantitative influence of typical structural materials of nuclear reactors on the reactivity balance can be investigated.

## 2. Tasks

1. The movement of structural material samples within the central experimental channel of the reactor is realised by a thin-walled aluminum leading tube. Within the tube, the respective sample is fixed at a particular position by distance holders. The tube is labeled in such a way that the position of the sample inside the reactor is determined as function of the distance  $r$  from the reactor core center (symmetry axis).
2. Before measuring the samples, the background reactivity of the leading tube is measured after filling it with distance holder elements only (i.e. without any structural material sample) and completely inserting it into the central experimental channel EK 1-2.
3. The reactivity characteristics  $\rho(r)$  are measured for samples made from different materials (e.g. absorber, scatterer, fuel, cavity).  
For this reason, the reactivity changes caused by position changes of the sample in the reactor is compensated using calibrated control rods. With help of the control rod characteristics (available at the facility as a result of control rod calibration) the corresponding value of change in reactivity can be determined.
4. The measured reactivity characteristics have to be discussed.
5. The composite and the interaction cross section of an unknown sample can be determined by comparison of the reactivity characteristic of the unknown sample with those of known samples.

## 3. Introduction

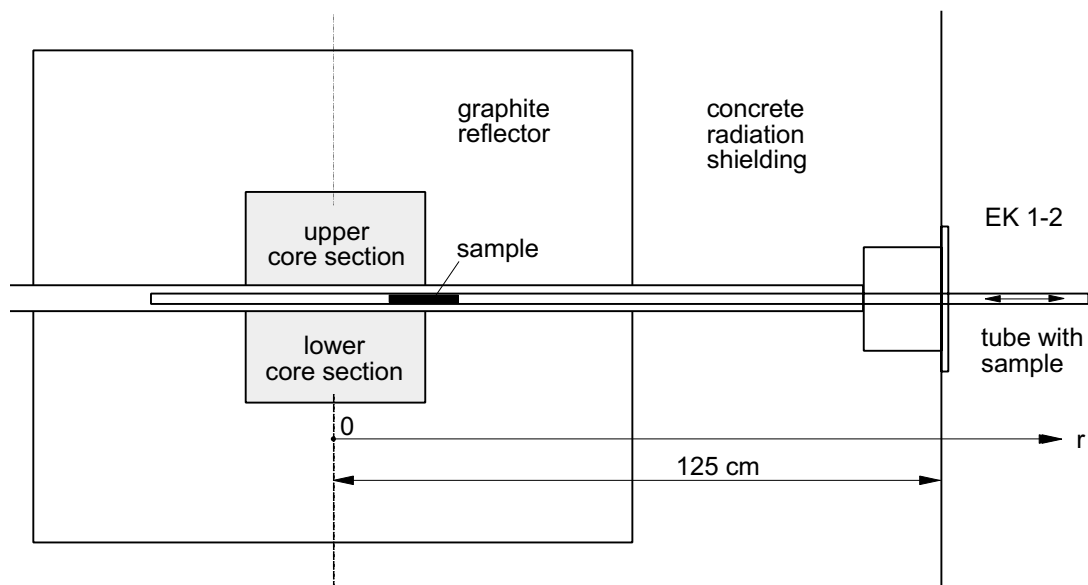
In the experiment "Control Rod Calibration", the influence of an absorber with small spatial dimension on the reactor core has already been discussed. It was shown that the reactivity loss caused by a differential part of the rod  $dz$  located at the position  $z$  is the larger

- the larger the macroscopic absorption cross section is,
- the larger the neutron flux density  $\Phi$  at the position  $z$  is, and
- the longer the rod part  $dz$  is.

This is a result of perturbation theory in one-group approximation.

In continuation to this problem, in the given experiment "Adjoint Flux Function", not only absorbers but also other materials (scattering materials, fuel, cavity) can be investigated. Their position relative to the reactor core will not be changed vertically but horizontally using the experimental channel EK 1-2 (see Fig. 1).

The theoretical background with reference to the application of perturbation theory to radial problems in a two-group approximation is given in the appendix.



**Fig. 1,** Experimental setup

#### **4. Instructions Concerning the Experiment**

##### **Attention!**

*Position changes of the sample in the experimental channel EK 1-2 can cause positive reactivity changes! Avoid rapid movements with combined large step lengths! The full withdrawal or insertion of the leading tube is only allowed for a partially shut-down reactor!*

1. Investigation of the influence of the empty aluminium leading tube
2. Investigation of the reactivity influence of the tube filled with distance holders only (determine the critical rod position)
3. Insertion of a scattering / moderator sample (cylinder of PE, 10 cm long) into experimental channel EK 1-2 using steps of 5 cm length each within a range from -30 cm ... 0 cm ... +30 cm (0 cm indicates the position of the reactor core center)
4. Plot of the adjoint flux for scattering material

5. Insertion of an absorber sample (cylinder of PVC, 5cm long) into experimental channel EK 1-2 using steps of 5 cm length each within a range from -30 cm ... 0 cm ... +30 cm (0 cm indicates the position of the core center)
6. Plot of the adjoint flux for absorber material
7. Possible repetition of points 5 and 6 e.g. for a graphite or a fuel sample

## **5. Instructions Concerning the Protocol**

- Short description of the objectives of the experiment
- Tables of the measured values
- Analysis of the measurements including intermediate results
- Graphical presentation of the experimentally found characteristics. For the absorber material, a comparison with the theoretically found characteristic should be given. The characteristic of the scatterer has to be discussed qualitatively.
- An error analysis has to be provided

## **6. Questions to Answer**

1. Make sure how to determine the reactivity, which is due to a particular sample and is compensated by a control rod, using a differential or integral rod characteristics!
2. What is the methodical difference between the determination of an integral control rod characteristics and the determination of the characteristics of a sample whose dimensions are small compared to those of the reactor core?
3. Consider a graphite sample (assuming: only  $D \neq 0$ ) being as a scatterer in the center of the reactor core ( $r = 0$ ). Why not  $\rho = 0$  has to be expected?
4. Make sure the procedure for the determination of the Uranium content in a sample using the reactivity characteristics!

## Appendix 1: Physical Background

As an approximation for the description of neutron transport we use the diffusion equation in the two-group approximation.

$$\text{div}(D_1 \cdot \text{grad } \Phi_1) - \Sigma_{\text{rem}} \Phi_1 + \varepsilon \cdot \nu \cdot \Sigma_{f,2} \Phi_2 = 0 \quad (1)$$

$$\text{div}(D_2 \cdot \text{grad } \Phi_2) - \Sigma_{a,2} \Phi_2 + p \cdot \Sigma_{s,1-2} \Phi_1 = 0$$

$$\text{with } \Sigma_{\text{rem}} = \Sigma_{a,1} + \Sigma_{s,1-2}, \quad \Sigma_{s,1-2} = \frac{\Sigma_{s,1}}{\frac{1}{\zeta} \ln \frac{E_0}{E_g}}$$

$$\text{and } D = \frac{1}{3 \cdot \Sigma_{\text{tr}}} = \frac{1}{3(\Sigma_T - \Sigma_s \cdot \bar{\mu})}, \quad \bar{\mu} = \frac{2}{3 \cdot A}$$

Small perturbations in the context of perturbation theory are deviations of the coefficients  $D_1$ ,  $D_2$ ,  $\Sigma_{\text{rem}}$ ,  $\Sigma_{a,2}$ ,  $\Sigma_{f,2}$ ,  $\Sigma_{s,1-2}$ , while it is assumed that the neutron flux distribution in the reactor is not changed by the sample.

Equation (1) has the following matrix representation:

$$\underline{M} \underline{\Phi} = 0 \quad (2)$$

If the sample that causes the perturbation  $S$  is introduced into the reactor, the reactor becomes subcritical or supercritical, i.e.

$$\varrho = \frac{k'_{\text{eff}} - 1}{k'_{\text{eff}}} \neq 0 \quad (3)$$

with  $k'_{\text{eff}} = k_{\text{eff}}^0 + \Delta k_{\text{eff}} \neq 1$  ... perturbed state

and  $k_{\text{eff}}^0 = 1$  ... unperturbed state

The perturbation caused by the change in the coefficients is compensated, e.g., by re-adjustment of the control rods. It results:

$$k_{\text{eff}} = k'_{\text{eff}} - \Delta k_{\text{eff}} = 1$$

Recriticality corresponds to

$$(\underline{\mathbf{M}} + \underline{\mathbf{S}}) \cdot \underline{\Phi} = 0 \quad (4)$$

$$\text{with } \underline{\mathbf{S}} = \begin{vmatrix} \text{div } \delta D_1 \cdot \text{grad } \Phi_1 - \delta \Sigma_{\text{rem}} & \boldsymbol{\varepsilon} \cdot \mathbf{v} \cdot \delta \Sigma_{f,2} - \Delta k_{\text{eff}} \cdot \boldsymbol{\varepsilon} \cdot \mathbf{v} \cdot \Sigma_{f,2} \\ \rho \cdot \delta \Sigma_{s,1-2} & \text{div } \delta D_2 \cdot \text{grad } \Phi_2 - \delta \Sigma_{a,2} \end{vmatrix} \quad (5)$$

The expression  $-\Delta k_{\text{eff}} \cdot \boldsymbol{\varepsilon} \cdot \mathbf{v} \cdot \Sigma_{f,2}$  represents the compensation of the perturbation.

After setting up the adjoint equation

$$(\underline{\mathbf{M}}^+ + \underline{\mathbf{S}}^+) \cdot \underline{\Phi} = 0$$

and by using eigenvalue theory and carrying out several steps of algebra, for  $\rho = \Delta k_{\text{eff}}$  follows

$$\varrho = \frac{1}{K_{\text{Reactor}}} \int [-\delta D_1 \text{grad } \Phi_1^+ \text{grad } \Phi_1 - \delta \Sigma_{\text{rem}} \Phi_1^+ \Phi_1 + \boldsymbol{\varepsilon} \cdot \mathbf{v} \cdot \delta \Sigma_{f,2} \Phi_1^+ \Phi_2 - \delta D_2 \text{grad } \Phi_2^+ \text{grad } \Phi_2 - \delta \Sigma_{a,2} \Phi_2^+ \Phi_2 + \rho \cdot \Sigma_{s,1-2} \Phi_2^+ \Phi_1] dV \quad (6)$$

$$\text{with } K = \int_{\text{Reactor}} \boldsymbol{\varepsilon} \cdot \mathbf{v} \cdot \Sigma_{f,2} \Phi_1^+ \Phi_2 dV$$

In the given experiment, especially the influence of an absorber (only  $\delta \Sigma_{a,2} \neq 0$ ) and the influence of a scatterer ( $\delta \Sigma_s \neq 0$ ) are investigated, i.e.

$$\varrho_a = - \frac{1}{K_{\text{Reactor}}} \int \delta \Sigma_{a,2} \Phi_2^+ \Phi_2 dV \quad (7)$$

for the absorber and

$$\varrho_s = \frac{1}{K_{\text{Reactor}}} \int [-\delta D_2 \text{grad } \Phi_2^+ \text{grad } \Phi_2 + \rho \cdot \delta \Sigma_{s,1-2} \Phi_2^+ \Phi_1] dV \quad (8)$$

for the scatterer, because a change in  $\Sigma_s$  causes changes in the diffusion coefficient and also in the slowing-down cross section (frequently called moderation fraction). For cavities, the same equations are applicable with reverse algebraic plus/minus signs.

Equation (6) shows that an increase in the cross sections  $\delta\Sigma_a$  und  $\delta\Sigma_{s,1-2}$  is weighted with  $\Phi^+\Phi$ , but a change of D is weighted with  $\text{grad}\Phi^+\text{grad}\Phi$ . An increase in the absorption cross sections results in a negative reactivity contribution. In the same way, an increase in the diffusion coefficient causes a negative reactivity contribution, since this corresponds to an increase in the leakage term.

Assuming that the perturbation occupies only a small part  $\Delta V$  of the total volume of the reactor with negligible influence of the neutrons, the integration in equations (7) and (8) can be avoided with the result:

$$\rho_a = - \frac{1}{K} \cdot \delta\Sigma_{a,2} \Phi_2^+ \Phi_2 \Delta V \tag{9}$$

$$\rho_s = \frac{1}{K} (-\delta D_2 \text{grad}\Phi_2^+ \text{grad}\Phi_2 + p \cdot \delta\Sigma_{s,1-2} \Phi_2^+ \Phi_1) \Delta V$$



## Appendix 2: Application of Perturbation Theory to Experiments at the AKR (One-Group Theory)

In one-group theory, it is  $\Phi_1 = \Phi_2$  und  $\Phi_1 = \Phi_1^+$ .

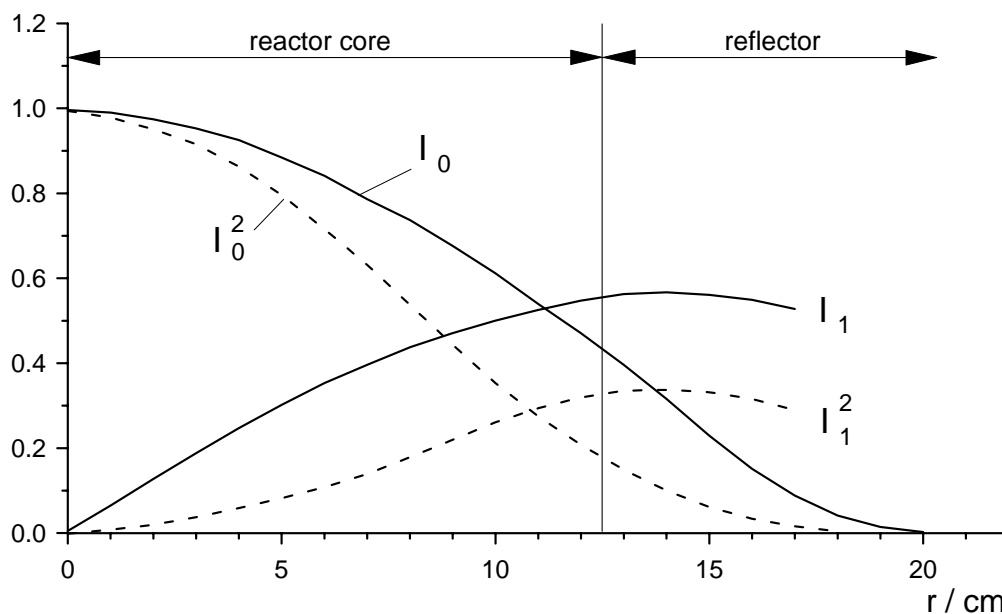
Having a cylindrical geometry like that of the AKR, the radial shape of  $\Phi$  and  $\frac{M}{M^*} \mathbf{M}$  can be expressed using BESSEL functions:

$$\mathbf{M}' = \mathbf{M}_{\max} \cdot I_0 \left( \frac{2.405}{R\%*} \cdot r \right)$$

$$\frac{M}{M^*} \mathbf{M}' = \mathbf{M}_{\max} \cdot \frac{2.405}{R\%*} \cdot I_1 \left( \frac{2.405}{R\%*} \cdot r \right)$$

with  $R = 12.5$  cm and  $\delta = 6.35$  cm.

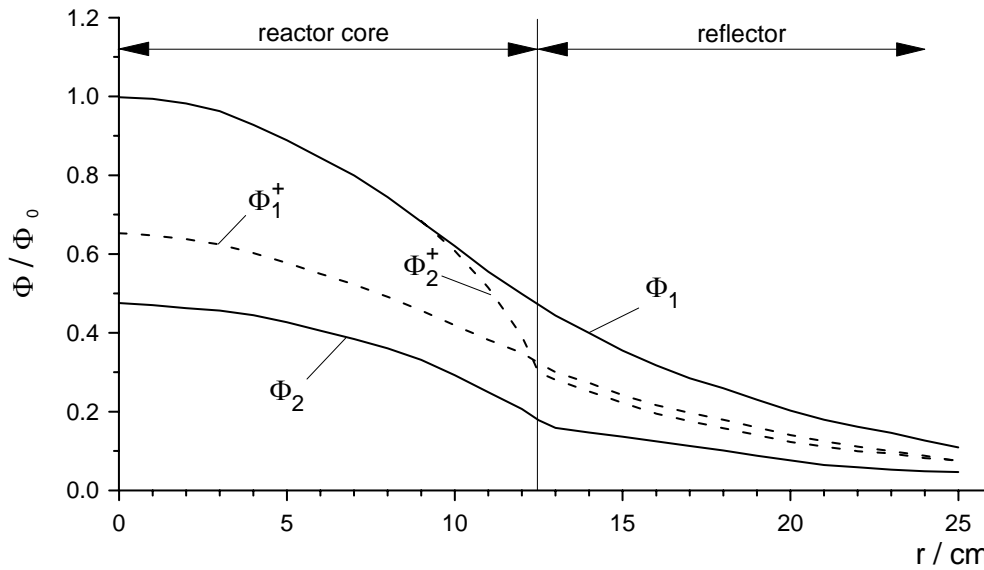
The approximation using one-group theory is well applicable for absorbers with small reactivities.



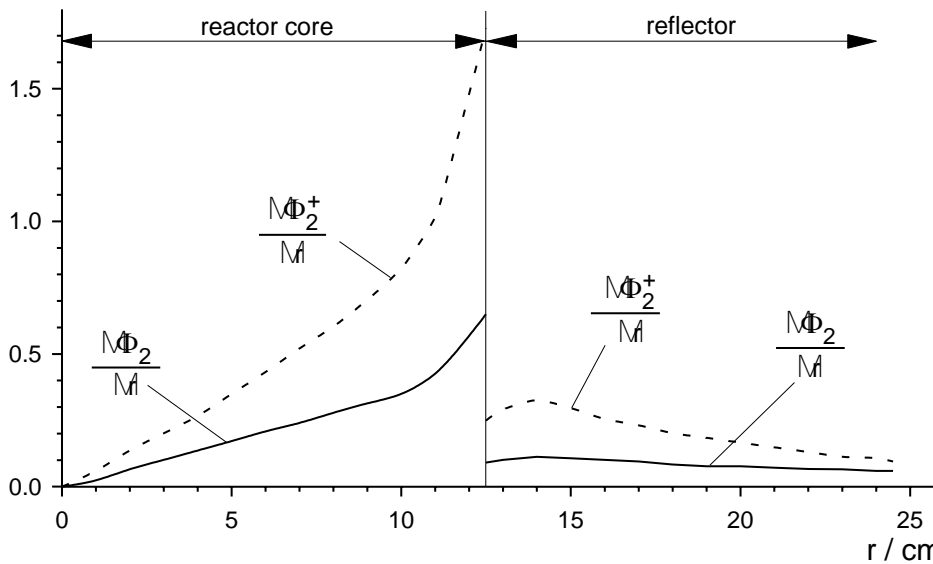
**Fig. 2,** Normalised BESSEL functions  $I_0$  und  $I_1$  and its squares for the radial dimensions of the AKR

### Appendix 3: Application of Perturbation Theory to Experiments at the AKR (Two-Group Theory)

Figure 3 shows the radial distributions of  $\Phi_1$ ,  $\Phi_1^+$ ,  $\Phi_2$ ,  $\Phi_2^+$ ,  $\frac{M}{M^*} \mathbf{M}_2$  und  $\frac{M}{M^*} \mathbf{M}_2^0$ , that were calculated for the AKR in the two-group approximation using the computer code RHEIN with the (one dimensional) transport method P1.

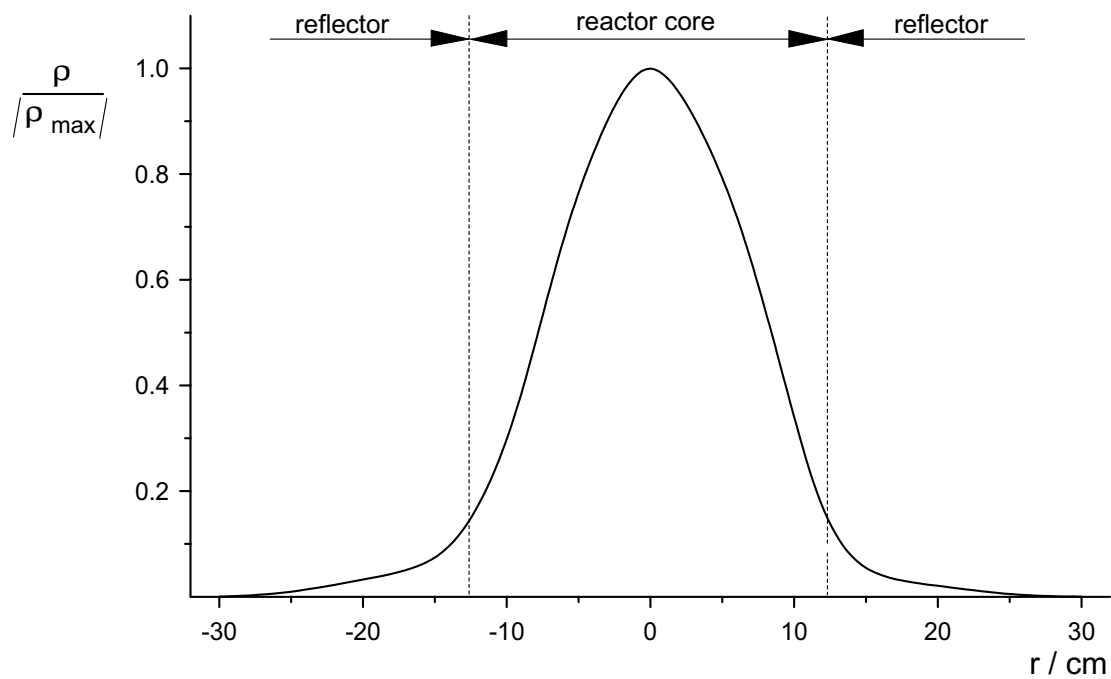


**Fig. 3a,** Radial distribution of the neutron fluxes and of the adjoint fluxes at the AKR

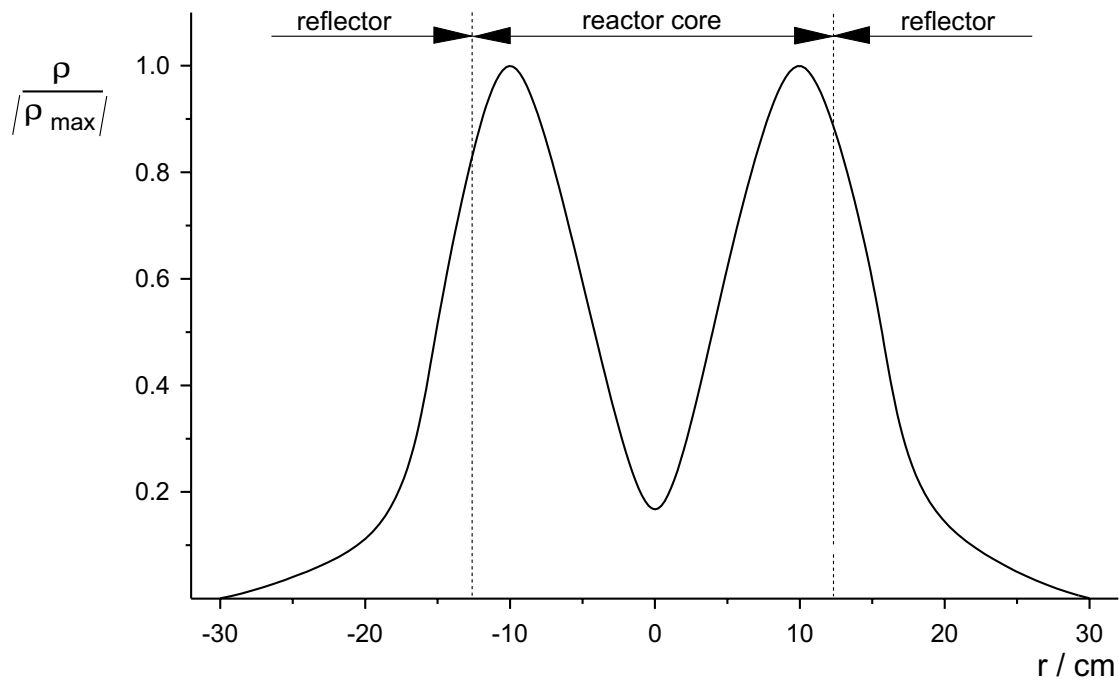


**Fig. 3b,** Radial distribution of  $\frac{M}{M^*} \mathbf{M}_2$  and  $\frac{M}{M^*} \mathbf{M}_2^0$  at the AKR

On the basis of their shapes, the experimentally determined reactivity characteristics of the AKR can be explained (see Figs. 4 and 5).



**Fig. 4,** Typical shape of an absorber characteristic in the AKR



**Fig. 5,** Typical shape of a scatterer characteristic in the AKR

## Appendix 4: Protocol forms

### 1. Empty sample tube with distance holders only (background measurement)

R / cm	S1	S2	S3	$\rho$ / cent
-30				
-25				
-20				
-15				
-10				
-5				
0				
+5				
+10				
+15				
+20				
+25				
+30				

### 2. Neutron scattering material (cylinder 10 cm polyethylen):

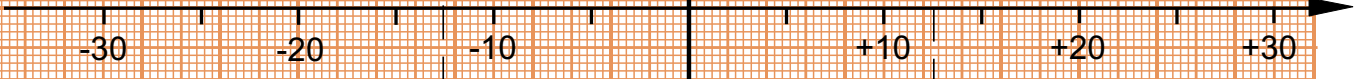
R / cm	S1	S2	S3	$\rho$ / cent
-30				
-25				
-20				
-15				
-10				
-5				
0				
+5				
+10				
+15				
+20				
+25				
+30				

3. Neutron absorbing material (cylinder 5 cm PVC):

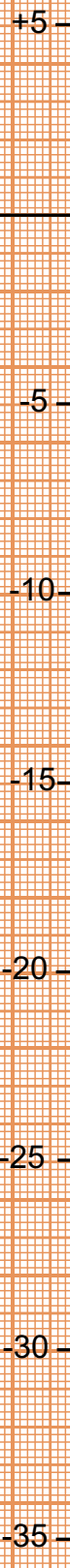
R / cm	S1	S2	S3	$\rho$ / cent
-30				
-25				
-20				
-15				
-10				
-5				
0				
+5				
+10				
+15				
+20				
+25				
+30				

Experiment  
"Adjoint Flux Function"

Reactivity  $\rho$  / cent



Radius R / cm



Core Diameter