

The Comparison of a convective TBK-Combustion to Oxyfuel TBK Combustion based on investigations into Nitrogen Oxide (NO) formation and respectively the reduction reactions in a 50 kW Pulverized Coal Combustion Test Facility

R. Wilhelm^{*.1}, S. Weigl¹, M. Beckmann¹

¹Department of Combustion, Heat and Mass Transfer,
Technische Universität Dresden
Germany 01062 Dresden

Abstract

This article describes the main differences between NO production by conventional air combustion and by the oxyfuel process. The article shows the impact of nitrogen contained both in the air and in the coal for NO production in connection with the process temperature and recirculation ratio based on results of research at a 50 kW Oxyfuel combustion facility and computer based modelling.

Introduction

The worldwide increase in energy demand above all in developed and newly industrializing countries has on one hand, led to a scarcity and consequently a price increase in the energy resources, and on the other hand an increase in CO₂ emissions. In order to *counter* both effects, new concepts into sustainable energy generation must be developed. Besides the increased use of renewable energy, lignite (brown coal) plays an important role in Germany's potential usage as an import independent and non-subsidized energy source. One way, for lignite to be used as an energy source and simultaneously not increasing the CO₂ emissions, is the so-called Oxyfuel-Process with CO₂ separation. The process is currently being developed. In the following paper, results from the experiments in an Oxyfuel Pulverized Coal Combustion Test Facility in view of the Nitrogen oxide formation will be evaluated. The 50 kW Pulverized Coal Combustion test facility provides the option for investigations into Oxyfuel Combustion and additionally in Air-Combustion. From the investigations, the tendencies concerning the emission behavior in different operational conditions can be derived. This article focuses on the differences in Nitrogen oxide formation and reduction.

NO_x - Formation

NO_x – formation occurs from the following mechanisms:

- fuel-NO
- thermal-NO
- prompt-NO.

The Nitrogen bound in the fuel is released during the gasification and subsequently in the hot flame it is initially transformed to NH_i – Radicals or HCN (hydrocyanic acid) [1][2]. The materials react with oxygen to form NO. The formed NO can be reduced from the present

NH_i – Radicals and under-stoichiometric conditions into desired molecular Nitrogen (N₂). The stoichiometric

ratio for minimum NO is foremost dependent on Fuel-Nitrogen content. In coal combustion the sum of the toxic substances from NO, NH_i and HCN is minimal at stoichiometric numbers by $\lambda = 0,7$, since at this point there is maximum transformation of fuel nitrogen into molecular nitrogen N₂.

In industry staged combustion is commonly applied and is divided into under- and over-stoichiometric combustion zones.

In Oxyfuel-Combustion, through recirculation of flue gas, an external recirculation of the flue gas is carried out. The flue gas recirculation leads to a reduction in the combustion chamber temperature and also to a reduction in the oxygen partial pressure in the burner and thus inhibits the NO-formation. When a lot of flue gas is recirculated and very low partial oxygen pressure in the burner occurs, the process is enhanced and certainly here the flame stability is the limiting factor. The mixing temperature of the reaction gas should lie above the ignition temperature of the fuel. The flame can be stabilized through the respective customization of the burner geometry e.g. through the intensification of the internal flue gas recirculation.

Thermal NO is basically formed through the reaction of molecular nitrogen (N₂ -from air) with oxygen to nitrogen oxide (NO) at over-stoichiometric conditions. The reaction occurs only at high temperatures, since the N₂- triple bond has very high activation energy [1][2]. Prompt NO is formed mainly in under-stoichiometric conditions. In this region, often the CH-radicals react with molecular nitrogen from the air to HCN and atomic N. Since the activation energy of the reaction is initially smaller, prompt NO is formed also at relatively low temperatures [1]. The HCN reacts then in multiple steps into NO.

An important difference in the formation of NO_x between air and Oxyfuel-combustion exists. The difference is due to the fact that in air combustion

* Corresponding author: ronald.wilhelm@tu-dresden.de
Proceedings of the European Combustion Meeting 2009

alongside the Fuel – NO formation also Thermal NO is formed from the nitrogen content in the air at high temperatures.

For the Oxyfuel-Process only the formation of NO_x from fuel is significant. The NO_x-Emissions based on the fuel used are in the Oxyfuel-Process lower or equal when compared to the staged air combustion.

The flue gas recirculation in the Oxyfuel-Process, as common in the flue gas recirculation, has an influence on the NO_x-reduction.

In the comparison of NO-formation it is necessary to state the basis of used fuel. The main reasons being that in the Oxyfuel-Process and Air Combustion Process there are different flue gas compositions and respectively also the densities of the flue gas.

Test Facility

Investigations into the Oxyfuel-Process were carried out in test facility shown in Fig 1.

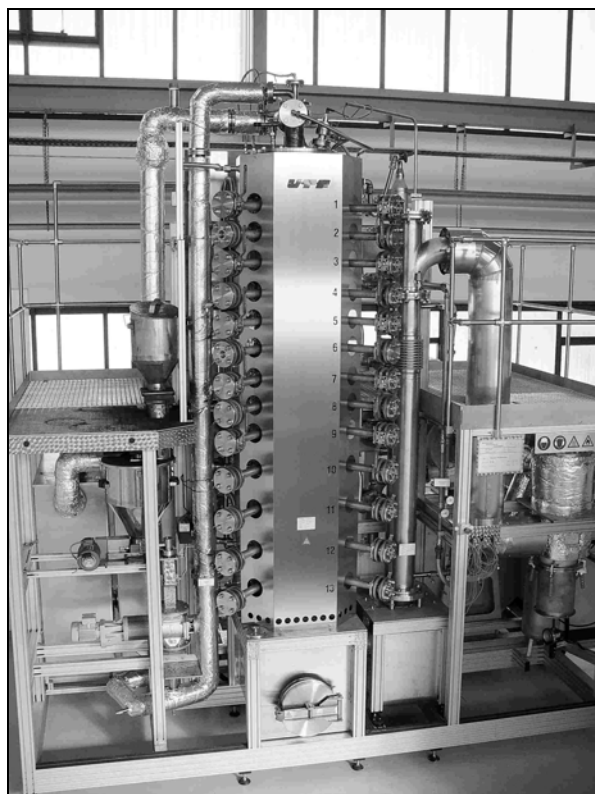

Fig 1: Pulverized Coal Combustion Test Facility at Technische Universität Dresden

The test facility has a thermal power of 50 kW_{therm} and alongside the convectional operational mode with air with varying options, it also allows the possibility of coal combustion with pure oxygen and recirculation flue gas („Oxyfuel“) to be investigated.

After the combustion chamber, the cooling of the flue gas occurs at about 200°C and filtration of the fly ash. A ventilator re-circulates the flue gas proportionally. The primary flue gas flow aids to the conveyance of the fuel. The oxygen in the secondary flue gas flow is dosed in a pre-mixture chamber of the process. The test plant is gas-tight and can represent an

ideal Oxyfuel-Process. It means that in dry flue gas conditions, carbon dioxide concentrations well over 95 % can be measured. Through defined dosing of in-leaked air (*false air*), a real Oxyfuel-Process can be investigated.

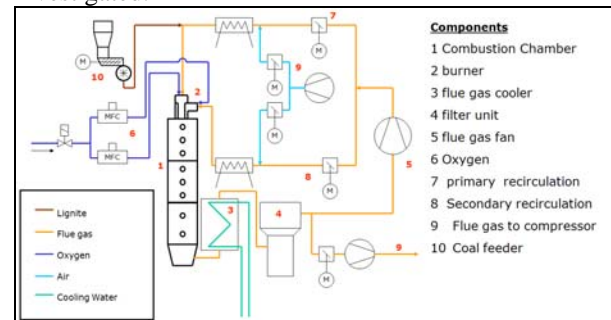

Fig 2: Process Diagram of Test Facility

The gas composition at the combustion chamber end is measured through convectional flue gas measuring techniques that are infrared based. With that, a partial flow current is sucked, dried and analyzed.

The flue gas parameters across the combustion chamber length are sucked by a special sensor. A Lock-technique enables the sensor application across the combustion chamber length without in-leakage air passing through. The analysis took place amongst other things with the use of measuring equipment from the FH Zittau-Gorlitz (University of Applied Sciences Zittau-Gorlitz), in which the research is aided through the Project ADECOS.

In order to closely determine the reaction conditions in the flame region, a temperature measurement with a suction pyrometer after VDI/DE 3511 at different combustion chamber positions was carried out. At the same points, particle samples were withdrawn, which were further analyzed in the laboratory specifically for the burnout and elementary composition.

Experimental Investigations and Evaluation - Definition of the Experimental Measurement Points

The Oxyfuel-Process can be entirely described through the oxygen concentration in the combustion chamber entry and exit.

The oxygen partial pressure at the entry of the combustion chamber is adjusted through the amount of the recirculated flue gas – thereby *Oxyfuel 25* means that 25 volume percent oxygen is present at the combustion chamber entry. For *Oxyfuel 17* there is higher recirculation whilst lower for *Oxyfuel 33*.

The targeted residual oxygen content at the combustion chamber exit defines the amount of oxygen that must be fed.

In-leakage air (*false air*) is fed before the combustion chamber in the Pulverized Coal Combustion test facility and is considered as additional oxygen entry. The target parameters are the oxygen concentration at the combustion entry and exit points.

For the characteristic experiments, the recirculation amount was varied at constant residual oxygen

concentration. For the flame investigations of the burner, in the combustion chamber a grid of the measurement points taken and evaluated.

Characteristic Experiments for the Oxyfuel Process

As mentioned in the introduction, the flue gas recirculation has an influence on the NO-formation.

In one of the experimental series (*Oxyfuel ideal*), the recirculation amount at the combustion chamber end was varied at constant residual oxygen of 4 Vol.-%moist. Through that the oxygen amount at the combustion chamber entry was varied in steps from 17 to 33 Vol.-%moist. Within these limits, stable operation of the plant is possible.

For the second step, at the same operational points, a fraction of 4 % in-leakage air (false air) is fed and with that possible real Oxyfuel-Process conditions are simulated (*Oxyfuel real*). In the results classification of the flue gas composition at the combustion chamber end, the comparison is done with air as the reaction gas, and with 4 Vol.-%moist residual oxygen in the humid flue gas (air comparison case).

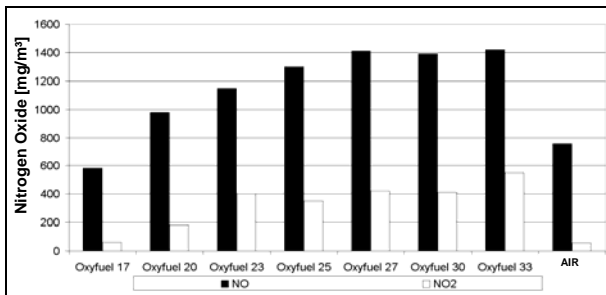

Fig 3: Nitrogen oxide concentration in flue gas / Oxyfuel process without in-leakage air

Fig 3 shows the measured Nitrogen oxide concentration in the flue gas for different pre-set conditions for *Oxyfuel ideal* and the related *air comparison case*. The Nitrogen oxide concentration is higher in almost all points in comparison to the *air comparison case*. It can be pointed out at this instance, that the comparison of the NO-concentration in the flue gas at different Oxyfuel-settings with the conventional comparable case with air as the reaction gas is not purposeful. The main reason being the different flue gas flow rates and the densities.

When the NO_x-concentration is compared to the specific flue gas volume and the lower heating value (*h_w*), it has to be based on the used fuel. The specifications units are therefore in milligram pro Megajoule fuel enthalpy (mg/MJ).

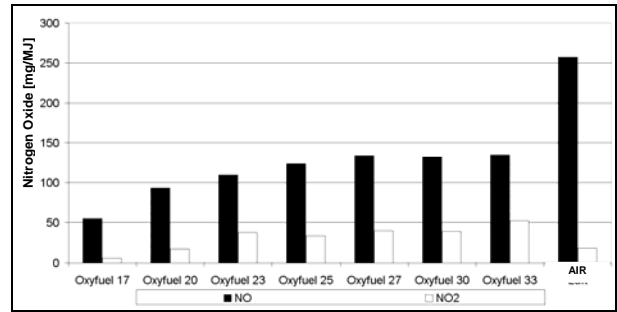

Fig 4: Nitrogen oxide formation in the Oxyfuel process without in-leakage air

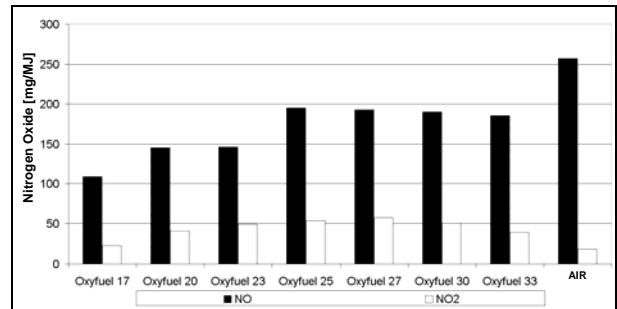

Fig. 5: Nitrogen oxide formation in the Oxyfuel-Process with 4 % in-leakage air

Through the basis reference of NO_x-Emissions on the used fuel enthalpy, it is therefore clear that the Oxyfuel_Process has significantly lower Nitrogen oxide (NO) is formed in all points when compared to air directed operations. Fig 5 shows the *Oxyfuel ideal* case and Fig 6 shows the values of the *Oxyfuel real* case. Also indicated are the measured values at a dry flue gas state.

In almost all Oxyfuel-Points, the NO_x-Emissions in comparison to the sum of the measured NO- and NO₂ emissions is higher than for the *air comparable case*. For this reaction the factor *f_{NO2/(NO+NO2)}* is shown below is applied.

$$f_{NO2/(NO+NO2)} = \frac{NO_2 [mg/MJ]}{NO [mg/MJ] + NO_2 [mg/MJ]} * 100$$

In-leakage air amount	Factor <i>f_{NO2/(NO+NO2)}</i>			
	Air	Oxyfuel 17	Oxyfuel 25	Oxyfuel 33
0 %	6,75 %	9,4 %	21,2 %	27,9 %
4 %	%	17,3 %	21,5 %	19,4 %

Table 1: Amount of NO₂ in comparison to NO-formation

Oxyfuel operations in contrast to air comparable case recirculate a large amount of flue gas. It therefore means that in recirculated flue gas at the combustion chamber entrance NO already exists and hence with increasing oxygen partial pressure more NO₂ is formed. As for the air comparable case, initially NO is formed. The remaining residence time is relatively shorter and

the available remaining oxygen partial pressure is clearly lower than at the combustion chamber entrance for Oxyfuel-Settings.

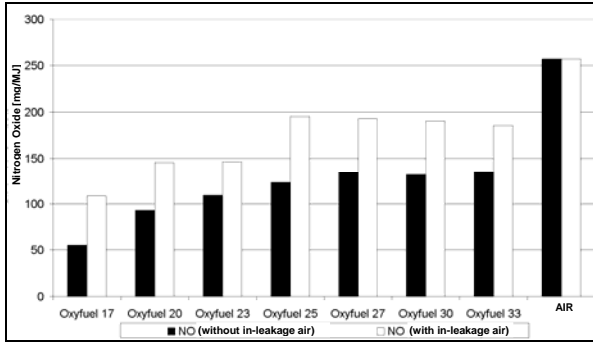

Fig 6: Comparison of the NO-formation for Oxyfuel *ideal*, *real* and *air comparable case* with variable recirculation rate.

Fig 6 shows the comparison of NO-formation in the Oxyfuel-Process with and without in-leakage air (4 % from combustion chamber flow rate) and the air comparable case. From these results 2 statements can be made:

- the lower the in-leakage air, the lower is the Nitrogen oxide formation and
- the higher the flue gas recirculation, the more intensified is the NO-formation reduction.

In the Oxyfuel process, it is therefore possible to have a clear reduction in the Nitrogen oxide emissions at defined boundary conditions. A lower in-leakage entry implies therefore higher standard requirements for the plant construction and with that also the manufacturing costs. The more material is recirculated, the bigger the flue gas ducts and ventilator dimensions must become. Therefore at this point exists a limit, which is determined by the economic boundaries and the energetic total efficiency.

Flame Investigations in the combustion chamber

For further investigations into the Oxyfuel-Process, a series of experiments with a single flame were carried out in the combustion chamber of the pulverized coal combustion test facility. From the sampling of particles along the combustion chamber at different radial positions and the subsequent elementary analysis, the reaction progress and the nitrogen release from coal can be evaluated. Parallel to that, emission measurements at the same sampling positions were carried out.

In Fig 7, the yield of the Nitrogen from the coal combined with the conversion rate NO/NO_{max} along the combustion chamber is shown. The conversion rate NO/NO_{max} indicates the mass ratio of the actual formed NO to the NO_{max} which could be formed, that's when all the existing Nitrogen is converted into NO. The high temperatures as expected are the reason for the rapid release of the fuel nitrogen at the combustion chamber

of the shown Oxyfuel points when compared to air operation case. For both cases, after 200 mm approx. 97 - 98% of the fuel nitrogen is released.

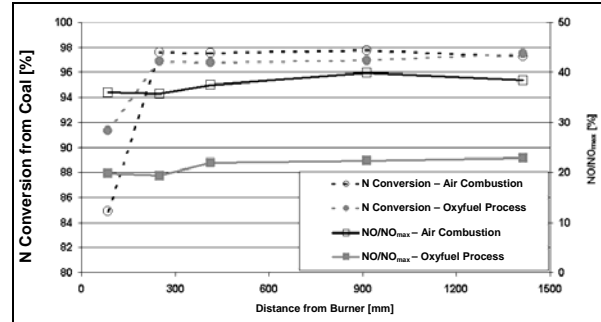

Fig 1: Illustration of the values from the emission measurements and the particle samples as average values / Examples : Oxyfuel 25 with 4% $O_{2,moist}$ and air with 4% $O_{2,moist}$

The conversion rate of NO/NO_{max} in the *air operated case* is higher than for the Oxyfuel *ideal case*. One reason to presume is the *propagated NO-Reduction* through the intensified flue gas recirculation from approx. 71 % in the Oxyfuel *ideal case*. The influence of the thermal NO-formation for the shown air comparison case plays a secondary role for a flame temperature of approximately 1200°C at the close-up range of the burner.

The pictures in Figures 8 to 10 show the concentration distribution of oxygen (O_2), nitrogen monoxide (NO) and nitrogen dioxide (NO_2) in the combustion chamber as examples for the Oxyfuel 25 case (*ideal*) with a residual oxygen content of 4 Vol.-%_{moist}.

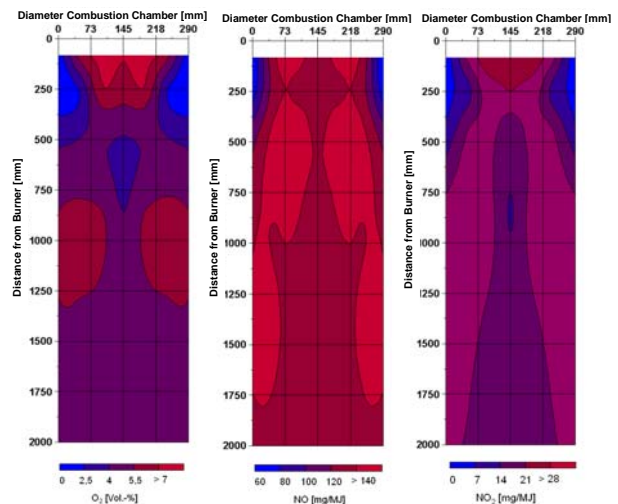

Fig 2 Measurement of O_2 in the combustion chamber eg.: Oxyfuel 25

Fig 3 Measurement of NO in the combustion chamber eg.: Oxyfuel 25

Fig 4 Measurement of NO_2 in the combustion chamber eg.: Oxyfuel 25

What can be noticed is the dependency of the NO-formation from the oxygen supply particularly directly at the close-up burner range of the combustion range. As earlier mentioned that the NO and NO₂ formation under stoichiometric zones is strongly inhibited and respectively a reduction of N₂ can occur. In the zone directly at the burner head, where the partial oxygen pressure is at its highest, exists as mentioned relatively higher NO₂-concentration. The absolute concentration of the NO₂ along the combustion chamber length remains constant and merely the distribution changes due to the fluid flow behavior.

Summary

The carried out experiments show that there is a difference in reference to the NO_x-formation between the convectional combustion (normal air conditions) and Oxyfuel combustion. The released energy based on NO_x-Emissions is for the *ideal* Oxyfuel process as well *real* process (with in leakage air) lower than for the air comparison case. For the Oxyfuel process the NO_x-Emissions can be further reduced through a higher flue gas recirculation rate. In this case not only the economic and energetic constraints but also the combustion technical limitations have to be considered.

The fraction of NO₂-formation from the total NO_x-production is for the Oxyfuel experimental tests higher in contrast to the air comparison cases due the higher NO supply from the flue gas recirculation and that is also with the associated longer residence time and the higher oxygen partial pressure.

References

- [1] Warnatz, J; Maas, U.: Technische Verbrennung, Springer-Verlag, Berlin, Heidelberg, New York, 1993
- [2] Joos, F.: Technische Verbrennung, Springer-Verlag, Berlin, Heidelberg, New York, 2006