

The Plenum Concept: Improving Scalability, Security, and Efficiency for Data Centers

Daniel Hackenberg
Center for Information Services and High Performance Computing
Technische Universität Dresden
01062 Dresden, Saxony, Germany
Email: daniel.hackenberg@tu-dresden.de

ABSTRACT

Data centers are very costly structures, both in terms of capital and operational expenditures. The high innovation rate in the IT business conflicts with the long-term character of data centers. In order to ensure lifetime usability, flexibility is a major concern for any data center design. Recent developments of data center air-cooling, in particular containment solutions for hot/cold air separation, allow rethinking of traditional data center design approaches. In this paper we present the *Plenum* concept that represents a major overhaul of traditional design principles. Our approach requires the construction of a full additional building story instead of a traditional raised floor. We then position the computer room air-handling (CRAH) units directly below the hot aisle of a block of racks. The downward flow direction of hot air makes the strict use of hot/cold air separation mandatory. Our approach minimizes or eliminates support space on the IT floor, moves almost all support structures into the *Plenum*, and creates very clean interfaces between both spaces. This greatly reduces the need for support personnel on the IT floor. Vice versa, IT personnel does not need to access support spaces, allowing for simplified data center operations. Insight from the planning process of a 5 MW data center currently under construction at TU Dresden shows that the construction of a full building story below the IT floor instead of a traditional raised floor does not necessarily increase the building volume. The simplified access and the separation of IT and support personnel reduces corridor and access spaces. We show that the overall building volume can even be decreased in comparison to classical approaches. Our design easily supports more than 15 kW average heat loads per rack with n+1 CRAH unit redundancy at a highly efficient CRAH operating point and with little scalability limitations regarding computer room size.

KEY WORDS: data center, air cooling, raised floor, plenum

INTRODUCTION AND MOTIVATION

Data center energy consumption is a major concern, both for the IT industry and the society in general, due to the associated cost and environmental implications. A simple yet highly effective method that has proven to strongly increase air-cooling efficiency and reliability in data centers is hot/cold air containment. It is a very established best practice for both retrofits of old data centers and construction of new sites [1], [2]. In comparison to traditional data centers without air containment, it vastly reduces the complexity of thermal processes in data centers by basically eliminating the three-dimensional airflow-modeling problem and reducing it to a

simple 1D problem. Hot spots in the computer room are eliminated and the outlet air temperature of computer room air handling (CRAH) units can be significantly increased, along with cold-water temperatures, free cooling times, and chiller efficiency.

In this paper we present a data center construction method that significantly improves scalability, air-cooling efficiency, and security compared to existing design approaches. The traditional raised floor is replaced by a full building story called *Plenum*. This concept allows for superior flexibility for installation and maintenance of all cooling and electrical distribution equipment. Several High Performance Computing (HPC) sites at least in the US, Switzerland and Germany have constructed full-height installation floors beneath the computer room and report significant advantages.

We extend this concept in two respects: First, there is a strong security advantage that is driven by moving as much of the non-IT support equipment from the computer room floor down into the *Plenum*. IT staff does not need access to the *Plenum* space, and non-IT support personnel does not need access to the much more fragile computer room space. Clean interfaces between both floors simplify data center operations. These advantages are especially important to more sensitive businesses outside the mostly scientific HPC sector, where security and availability are critical.

The second and more important extension of the *Plenum* concept in comparison to pre-existing installation floors is the placement of computer room air handling (CRAH) units right beneath every hot aisle. Only strict air containment on the computer room floor enables a downward flow direction of hot air into the CRAH units. Cooling air paths and pressure drops are reduced to a bare minimum, thereby significantly reducing CRAH power consumption. The concept is particularly effective for very high thermal loads per given area, which is in line with the ongoing trend towards higher integration and increased power densities of IT equipment. Moreover, modularity and scalability of a data center are greatly improved, as the air-cooling capacity naturally scales with the size of the IT space.

The discussion and proposed ideas in this paper are only applicable to data centers with strict hot/cold air containment and conventional air cooling with water-cooled CRAH units that are typically (but not necessarily) cooled using chillers and cooling towers. Moreover, the concept is applicable to water-cooled IT infrastructures, in particular the highly energy-efficient and increasingly popular hot-water cooled HPC systems. Retrofits of existing data centers as well as data centers with free outside air cooling are beyond the scope of this paper.

STATE-OF-THE-ART DATA CENTER AIR COOLING

Conventional Air Cooling w/o Containment

Traditional air-cooled data center design principles rely on under-floor cold air supply, hot/cold aisle rack setup, and hot air return within overhead air ducts or suspended ceilings. CRAH units are located on the same floor on the side of the IT room, in many facilities physically separated with access for support personnel but not IT staff (administrators) to reduce the risk of faulty or unsupervised operation of these units.

The most important issue in traditional data centers without hot/cold air containment is the non-uniform IT inlet air temperature. Typically (but not necessarily), the coolest inlet temperature is at the bottom of the rack, and the highest temperature is at the top of the rack, as depicted in Figure 1. This effect is driven by air recirculating from the hot to the cold aisle, mostly above the racks but also through unused rack slots without blind plates, around the sides at the end of a row of racks, and even beneath the racks [3].

As a result of this air recirculation, computer rooms become a very sensitive space in terms of air temperature. Based on the specific rack layout, perforated floor tile and overhead air exhaust vent placement, density of the IT systems, and IT load, a complex and usually unpredictable temperature distribution occurs. This naturally involves hot spots to the extent that IT air inlet temperatures in these areas are often even above the CRAH inlet temperatures. Hot spots force data center operators to reduce the CRAH exhaust air temperature way below the upper (or even below the lower) limit of the recommended ASHRAE temperature range, decreasing efficiency of both free and chiller-based cooling.

In order to reduce hot spots and optimize data center air temperature uniformity, a large body of research advocates for data center modeling using computational fluid dynamics (CFD) simulations in order to find and evaluate possible countermeasures [4, 5]. Other work discusses algorithms for local temperature control [6], airflow uniformity [7] and even the ideal design of perforated floor tiles [8]. In the next section we discuss very simple measures for air containment that have proven to be a much more straightforward and effective means to address air temperature challenges in data centers.

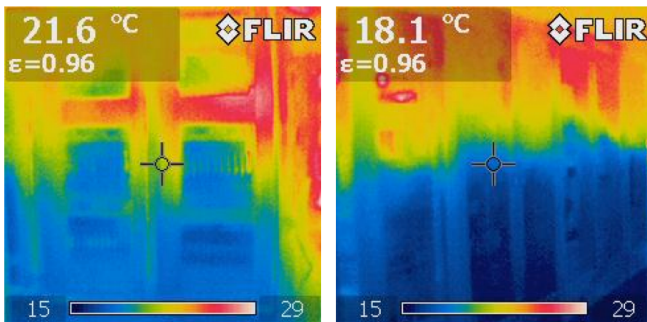

Fig. 1 Thermal image from a server room without hot/cold air separation; hot air recirculates above the racks, significantly increasing the inlet air temperature of the uppermost servers

Hot/Cold Air Separation

The separation of hot and cold air presents a major opportunity to increase energy efficiency in data centers [1, 2]. An alternating hot/cold aisle layout is usually present even in older data centers. Perforated floor tiles will only be installed on the cold aisle, air exhaust vents will only be placed above the hot aisle. To implement a containment, empty slots in the IT racks as well as all other open spaces in the racks need to be covered with blind plates that are available as standard parts from all major rack manufacturers. Spaces above and at the side of the racks also need to be covered. One of the cheapest and simplest options for this are plastic curtains (fire load is an issue here). With little effort, data center temperature distribution can be vastly improved.

Figure 2 shows racks in a fairly small computer room after being retrofitted with blinding plates and plastic curtains. The room represents a worst-case scenario in many ways, e.g. due to minimal raised floor heights, lots of installation (e.g. pipes) in the raised floor, and insufficient height for air ducts or a suspended ceiling. Despite these significant issues, IT air inlet temperature is almost constant from top to bottom and about 1°K above the CRAH exhaust temperature. Compared to the previous configuration without air separation, we were able to increase CRAH exhaust temperature by about 10°K and still decrease the air inlet temperature of the hottest IT system by several degrees. After adjusting cold-water temperatures and free cooling ranges, the resulting return-on-investment of this retrofit was in the order of several days. Significant reliability improvements are another advantage. Despite the increased temperature, the two CRAH units in this room are now redundant, as the improved efficiency enables a single CRAH unit to carry the full cooling load. Even a human error that led to a cold-water outage of more than 30 minutes and cold-aisle temperatures of above 30°C was overcome without a single IT system failure. This would definitely not have been possible before the installation of the air containment.

In the past, networking equipment has been a major concern regarding strict containment and increased cold aisle air temperatures. Routers and switches often use side-to-side or side-to-back instead of front-to-back airflow, thereby using hot aisle air at their inlet in contained environments

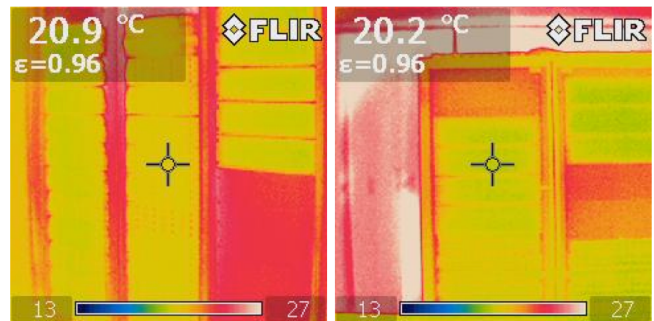

Fig. 2 Thermal image from a server room with hot/cold air separation; containment surfaces such as blind plates are heated from the back side, but the IT air inlet temperatures are basically constant across the whole rack

and creating air recirculation that increases the temperatures of networking gear even more. However, the industry has addressed this issue and all major equipment is now available in full-depth configurations with front-to-back airflow. The major driving force behind this process is provided by the ASHRAE Thermal Guidelines for Data Processing Environments [9]. The ASHRAE Networking Thermal Guidelines [10] make a particularly strong case with respect to containment-ready networking gear.

Hot/cold air separation represents a major change with respect to the theory of data center thermals. Traditionally, only expensive and time-consuming CFD modeling was able to capture air movement and thermal effects in the computer room. With the increasing energy-proportionality and the much more sophisticated fan control algorithms of today's IT systems, air temperature and airflow patterns are far from constant and instead strongly depend on IT load. These temporal effects make CFD-based modeling and hot spot control in computer rooms without containment even more challenging. In contrast, server rooms with well-implemented air containment represent a simple, one-dimensional system (see Figure 3). Modeling of such a system is by far simpler than performing a CFD-based data center analysis.

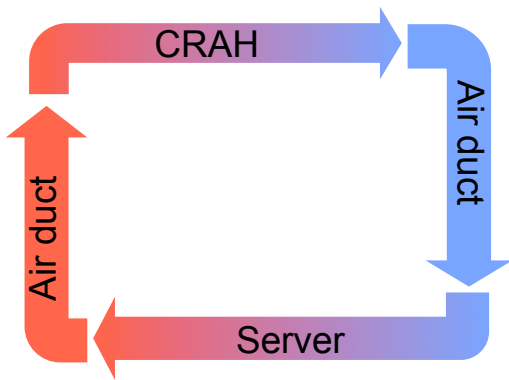

Fig. 3 The simple one-dimensional system that describes thermals in data centers with hot/cold air separation

With well-controlled CRAH units, server rooms with containment feature almost constant cold air temperatures within the raised floor and at any point within the contained cold air volume [11].¹ IT outlet temperatures are a simple function of IT inlet temperature, load, and volumetric flow. CRAH inlet temperature is slightly below IT outlet temperature due to the slightly higher air pressure on the cold side of the containment and the resulting cold air that bypasses through gaps in the containment (see next section). This seemingly trivial consequence of the air containment is of utmost importance and basically eliminates the need for CFD modeling of computer rooms.

¹ Parasitic heat transfer based on convection and radiation from racks or IT equipment surfaces typically only represent a negligible portion of the overall heat load. In data centers with reasonable power densities, the heat load creates air speeds that are high enough to mix up the cold air volume and capture any parasitic heat loads without notable temperature differences within the cold air containment.

Controls

Even today, many traditional data centers use outdated CRAH control algorithms that adjust both CRAH fan speed and CRAH cold water valves based on return air (CRAH inlet) temperatures. This concept is flawed, most importantly due to load-dependent CRAH exhaust (IT inlet) temperatures. For IT functionality and reliability, only IT inlet air temperature is relevant [9], [12].

Implementing effective CRAH controls in computer rooms with air containment is well-researched and straightforward. Airflow volume needs to be controlled based on the need of the IT systems. If server fans speed up, e.g. due to increased IT load, CRAH fans need to speed up as well. This is the first of two control loops as depicted in Figure 4. It ensures sufficient airflow by always providing slightly more airflow into the contained cold air space than the IT needs. This prevents hot air from recirculating through small gaps in the containment into the cold air space in favor of some cold air that bypasses into the contained hot air space. The fans of all CRAH units that exhaust into the same air plenum will typically be controlled in parallel. The sensors of this control loop can be based on airflow (anemometers), temperature, or differential pressure [13].

The second control loop depicted in Figure 4 is dedicated to temperature. All CRAH units that exhaust into the same air plenum should have identical outlet air temperature set points. Due to potentially non-uniform CRAH inlet air temperatures, each unit needs to control its cold water valve individually. From an efficiency standpoint, CRAH outlet / IT inlet temperatures should be close to the upper limit of the ASHRAE recommended temperature range of 27°C [9]. This allows for increased cooling water temperatures, which in turn maximizes free indirect cooling. If free cooling is not an option due to outside air conditions, increased cooling water temperatures are also favorable for chiller efficiency (COP). In order to reduce IT fan speeds and in turn IT-power usage effectiveness (ITUE [14]), temperatures may be reduced during favorable outside air conditions that allow for decreased cold water temperatures with little or no additional energy consumption.

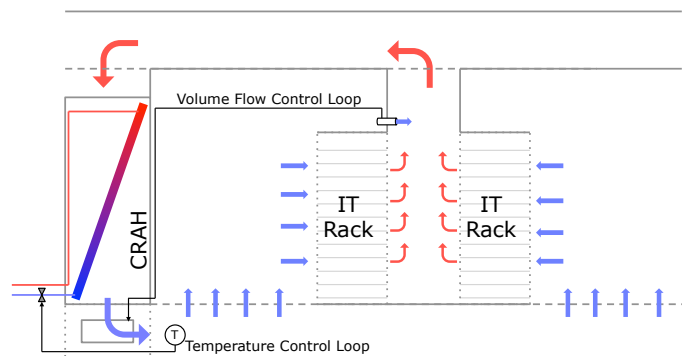

Fig. 4 Two separate control loops for the CRAH unit: 1) fan speed controlled by required air flow of the IT systems, 2) cold water valve controlled by CRAH outlet temperature

Hot Aisle vs. Cold Aisle Containment

The advantages and disadvantages of hot aisle vs. cold aisle containment and vice versa have been investigated and discussed intensively. The most important fact is that none of the two solutions offers a relevant energy efficiency advantage over the other [15]. Another highly relevant aspect is the potential temperature of the IT outlet air. ASHRAE argues that “With good airflow management, server temperature rise can be on the order of 20°C, with an inlet of temperature of 40°C the hot aisle could be 60°C” [9]. As a consequence, IT outlet air could become harmful for personnel and some materials in the future, although one could argue that 40°C inlet air temperature may never be the most efficient point of operation. Therefore, future-proof data center designs need to minimize materials and surfaces areas that are exposed to hot air. Slightly extended, we argue that it is desirable to minimize overall hot air volume. As a consequence, hot air containments should be generally favored. This means that only the space in between two rows of racks that are positioned back-to-back to each other as well as the air ducts from there to the CRAH units carry hot IT exhaust air. Personnel that enters the server room will enter the colder side of the air containment. Moreover, the IT personnel should be able to perform as much work as possible without entering the hot air containment. More and more server products feature front-side networking ports and other connectors instead of the traditional back-side cabling, thereby moving some of the most service-intensive workflows from the hot aisle to the colder front-side of the servers.

DATA CENTER CONSTRUCTION PRINCIPLES

Limitations of Classical Concepts

The constructional design of data centers needs to adhere to a number of functional principles to ensure physical security, energy-efficient operations and flexible expandability. The latter is a particularly important requirement, as capital expenditures for data center construction are substantial and projections of future floor space and power demands are often speculative and unreliable. A common solution are modular concepts that do not require a single large server room, but a number of smaller, identical units. Their number can be increased as needed. Figure 5 shows an example of such a modular concept with three server rooms. Common, but not shown here, is also the placement of infrastructure support rooms on two sides of the structure (physically separated for A/B redundancy) in a modularly extensible fashion. This includes supply infrastructure such as chillers, cooling towers, UPS systems and emergency backup generators.

Spatial separation of IT personnel and infrastructure staff is also a common design principle. Minimizing the access of personnel to server rooms reduces the risk that sensitive IT systems are accidentally damaged or deliberately tampered with. Ideally, maintenance technicians for non-IT systems should not have access to server rooms. Following this concept, CRAH units should not be installed in the server room, but spatially separated. Figure 5 shows a typical layout with CRAH units located on the side of the server room. The size of server rooms is limited by a combination of IT rack po-

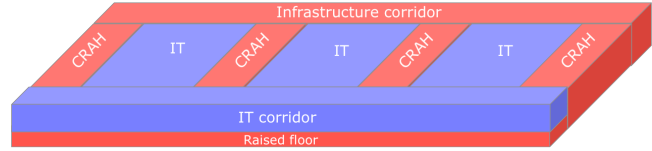

Fig. 5 Classic modular data center design: IT space (blue) and supply infrastructure (red, with corridor, CRAH unit rooms and raised floor)

wer density and raised floor height. High power density requires high volumetric flow, high volumetric flow requires large cross-sections, and large cross-sections require large raised floor heights. Raised floor height is costly, and this triggers the need to have CRAH units nearby, thereby limiting the size of the individual server room modules.

Another disadvantage of the traditional data center is the raised floor as depicted in Figure 5. It is typically used for cold air distribution, power distribution and often also for cold water distribution. It therefore needs to be considered as a non-IT space. However, access is only possible from the IT floor, which limits the options for separation of IT and non-IT staff significantly.

Alternative Concepts

With hot/cold air separation, the data center can be designed to transport of one of the two air flows not in the raised floor or a suspended ceiling, but in the computer room itself. It is therefore possible to discard the raised floor and save significant costs. A number of data centers have already been constructed this way. Figure 6 shows a cross-section through a server room with this configuration. The cold air is transported in the computer room itself, while the hot return air is guided through air ducts or a suspended ceiling back to the CRAC units. The use of a hot-aisle containment is imperative. Much supply infrastructure, e.g. for power distribution, needs to be installed within the IT space.

Another alternative is to build the raised floor, but discard air ducts and suspended ceilings. Typically, this concept will

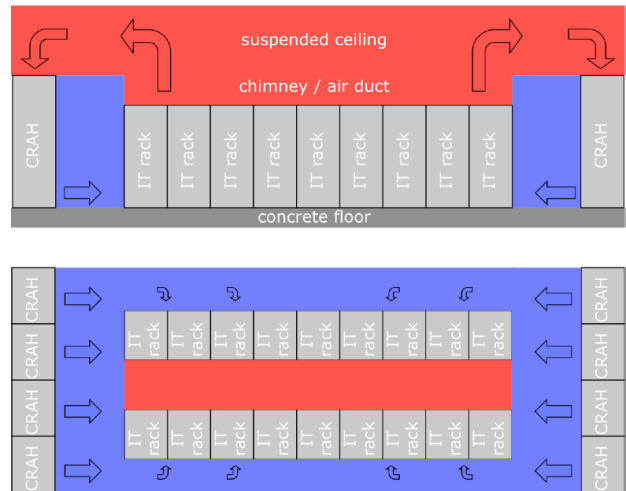

Fig. 6 Vertical and horizontal cross-section of a data center room without raised floor; cold air (blue) is transported within the room, hot air (red) is transported within the suspended ceiling

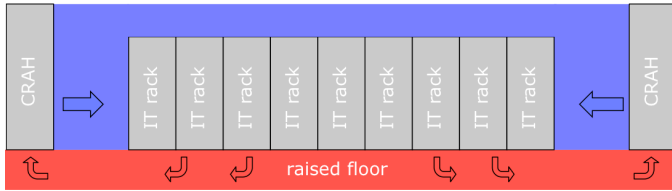

Fig. 7 Vertical cross-section of a data center room without suspended ceiling; cold air (blue) is transported within the room, hot air (red) is transported in the raised floor

be used with cold aisle containment and the hot room is used to transport return air back to the CRAH units. However, we argue that hot aisle containment should be favored and therefore show a more unusual option in Figure 7. The room is used to transport cold air, while the return air is transported through the raised floor back to the CRAH units. The downward flow of hot air is only possible with a very consequent use of air containment and properly implemented volume flow controls (see Figure 4) to prevent hot air from exiting the hot aisle into the cold room. Due to thermal radiation and convection on the racks and the air containment surfaces, a certain amount of heat transport into the room is unavoidable. Since no hot air extraction occurs at the computer room ceiling, temperature stratification in the room is expected. There are no practical experiences yet regarding the quantitative effects and whether this temperature stratification takes place only above the racks or whether it notably affects the inlet of the uppermost IT systems as well.

Another possible option is the positioning of the cooling coil directly above the contained hot aisle. First approaches in this regard are described in [16]. However, the use of water above the IT racks is often dismissed in sensitive data center environments due to the fear of water leakage. As an alternative, cooling registers may also be placed directly below the hot aisle (see Figure 8). Again, the downward flow of the hot air is unusual, but no serious issues are expected. No air ducts or suspended ceilings are required. However, the raised floor needs to be constructed as a regular building story, which has already been successfully implemented (without the proposed cooling concept) in other data centers as described

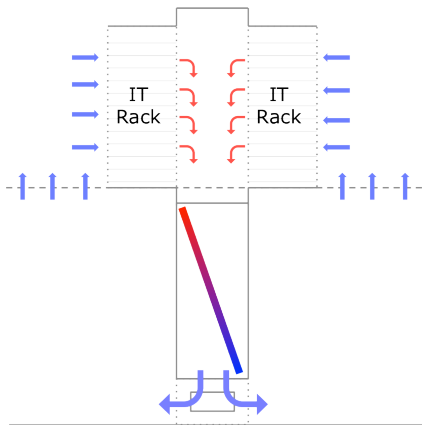

Fig. 8 CRAH unit placement directly below the hot aisle; requires strict hot/cold air separation on the IT floor and a raised floor constructed as a full building story

later in the paper. In addition, this design offers a number of significant advantages (see next section). One of the most important aspects is the inherent scalability, as the available cooling capacity increases automatically with the IT floor space. The available free cross-sections for air transportation are very large and no air ducts with bends induce additional pressure losses, making the design extremely energy-efficient.

THE PLENUM CONCEPT AND ITS REALIZATION

Challenges and Solutions of a Data Center Construction

At TU Dresden, a new 5 MW data center is currently under construction. The requirements for this building are complex and include the goal of a strict separation of IT and infrastructure personnel. The data center will be used for three different availability levels. Data processing for a local hospital represents very high availability requirements, while the installation of scientific high performance computing (HPC) resources only poses moderate requirements.

The data center needs to house traditional air-cooled server and storage systems with sufficient options for very high power density to ensure that the building can meet the requirements over its full lifespan. Direct free cooling with outside air was not an option. Temperature and humidity requirements are based on [9] with a focus on high water temperature to ensure energy-efficient operations. In contrast, tape-based storage for long-term archiving needs a separate room with much tighter control of temperature and humidity. Finally, a space for HPC systems requires very high power densities and (direct) water-cooling, including an option for chiller-free hot water cooling. Waste heat in this loop needs to be captured for reuse in the heating systems in surrounding campus buildings.

While a traditional design approach in accordance to Figure 5 had been considered during preliminary planning phases, several aspects turned out to be extraordinarily challenging. Most importantly, the power density and the required flexibility for future modifications or extensions of the support infrastructure as well as security concerns were incompatible with the limitations of a traditional raised floor. Knowing the installation floors of other HPC sites, a similar solution was developed. However, a fundamental change to the traditional design of server air room cooling was made: in all server rooms with hot aisle containment, CRAH units will be placed directly beneath the hot aisle (see Figure 8). We refer to this installation floor as *Plenum*.

The resulting layout (Figure 9) is vastly simplified in comparison to traditional layouts (Fig. 5). A clear separation of the responsibilities of IT staff (computer room level) and infrastructure personnel (*Plenum*) will have a strong influence on data center operations as discussed later in the paper. The clean layout is also beneficial with respect to physical security. It is important to note that an initial and more traditional design with the same specifications was created in this project (about 1,300 m² IT space). The fundamental design change did significantly increase floor space, as the traditional raised floor is not counted separately, while the *Plenum* is. However, in terms of volume the size of this data center was decreased by about 10% after changing the design to the *Plenum* concept.

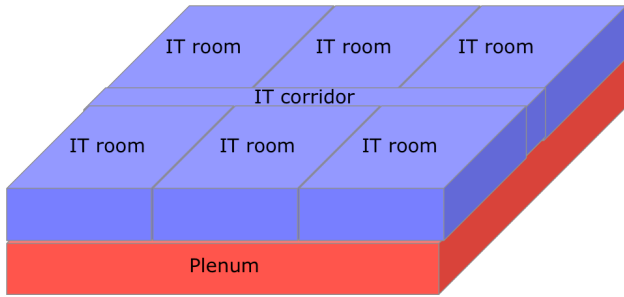

Fig. 9 Data center structure with IT rooms on the upper floor and full-story *Plenum* on the lower floor

Analysis and Evaluation of the Air Cooling Concept

To implement the *Plenum* concept, hot-aisle air containment is mandatory. Dual rack rows of arbitrary length form so-called containment blocks. The CRAH units installed in the *Plenum* have a fixed assignment to the containment block above. For n+1 redundancy of the CRAH units, longer containment blocks are advantageous because one redundancy unit must be provided for every hot aisle block. Figure 10 depicts the IT racks on the computer room level in a hot aisle arrangement (back-to-back) and below each hot aisle the corresponding CRAH units. Note the circular direction of hot/cold air movement and the complete lack of any narrow cross-sections.

An essential feature of this air-cooling solution is the unique combination of very high power density, energy efficiency, and scalability. The latter is achieved by directly associating the CRAH units to containment blocks. Therefore, cooling capacity naturally scales with the size of the computer room floor. This is a fundamental difference to the classic approach that places CRAH units on the computer room side. The high efficiency is mainly achieved through the unimpeded transport of air in the room. The smallest cross-section that the airflow has to overcome is determined by the suction opening of the CRAH unit. The nozzle above the CRAH widens for the

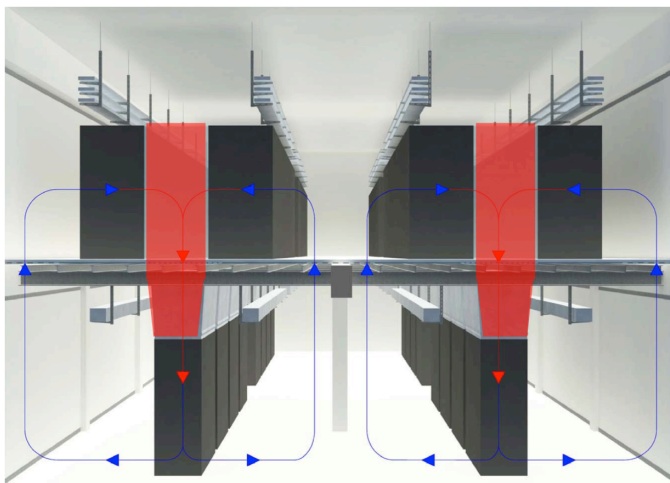

Fig. 10 IT floor with racks (top) and *Plenum* with CRAH units (bottom); note the short airflow paths and the minimal hot air volume (red).

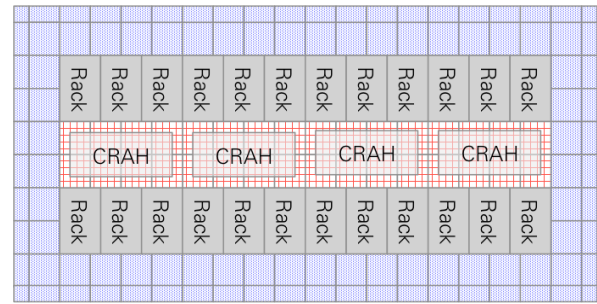

Fig. 11 Hot air containment block with 24 racks on the IT floor and 4 CRAH units within the *Plenum*

connection to the hot aisle which is two floor tiles wide (120 cm). Moreover, air-based heat transport only occurs over a short distance to the CRAH unit. From there, the design intends a much more efficient, water-based heat transport.

Figure 11 depicts an example for a containment block, in this case consisting of 24 racks (80 cm wide). Hot aisle width is two floor tiles, cold aisle width is three floor tiles. This provides sufficient space for all typical data center workflows. 75 floor tiles per block are available for cold air to move in from the *Plenum*, and 32 floor tiles are available to move hot air down to the CRAH units. Assuming a cooling capacity of 400 kW per block (in average 16.7 kW per rack or 6.5 kW per m²) and 16.3°K differential temperature, an airflow of 78,000 m³/h is required. This requires less than 10 Pa differential pressure on the cold aisle side even with floor tiles with only 24% free cross-section that are very convenient and do not handicap day-to-day operations within the cold aisle. For the hot aisle, 38% free cross-section would result in about 15 Pa pressure drop, but much larger free cross-sections are possible with grid tiles. In this configuration and with state-of-the-art CRAH units, an IT inlet temperature of 22°C can be achieved with very high water temperatures of 19/25°C and a fan power consumption of only 7.3 kW per containment block (PUE overhead: 0.018).

Operation Reliability, Serviceability, Flexibility

Besides the highly efficient air movement and very high air-cooling density using conventional CRAH units, the *Plenum* concept features several other advantages. Essential is the highly flexible usage of this space that is possible in comparison with traditional raised floors. Cold water pipes and power bars are natural fits for installation on this floor. Collision risk of electrical and cooling distribution is greatly reduced and the planning process is simplified. With the increasingly popular PP/PE piping, infrastructure extensions as well as dismantling can be performed during normal operation. In any case, a generous workspace and access is guaranteed for installation and no access to the sensitive computer room floor is required.

Already today, water-cooling is a common technique in the HPC space. For standard IT it is still too expensive and too unhandy, but this may change in the future. The *Plenum* concept offers a wide space to install cooling pipes. The data center at TU Dresden even features blocks that offer two cooling loops for both cold and hot water cooling.

The *Plenum* can also be used to install manifolds, pumps, and heat exchangers. Moreover, (de)humidification equipment should be installed here, as well as the detectors of early smoke detection systems.

The IT data cabling is installed above the racks on the computer room floor. This provides a very consistent separation of IT systems and supply infrastructure with clearly defined interfaces. Infrastructure technicians only need access to the IT level in rare cases and all rough workflows are limited to the *Plenum* level. We have previously argued that there are good reasons to minimize hot air volume. The highlighted red sections in Figure 10 demonstrate that the *Plenum* concept also fulfills this requirement exceptionally well. This reduces the possibilities of air leakage and thus limits inefficient air short circuits to a minimum. It also offers the potential to minimize the number of components or materials that have contact with hot air, which is advantageous in terms of the long-term usability of data centers with this design.

Other Data Centers with Installation Floors

The High Performance Computing Center Stuttgart (HLRS) has constructed the raised floor of its data center as full story. This installation floor is being used for IT data cabling, power distribution, cooling water and air distribution. Electrical sub-distribution units are located directly beneath the High Performance Computing (HPC) systems. Hot air is moved from the IT floor via overhead air ducts to the CRAH units that are located on two sides of the installation floor. The concept allows the installation of cold aisle containments, although these systems pollute the IT floor with uncontained hot air which could influence nearby systems that use at least some amount of air cooling without being placed in a cold aisle containment as well.

The data center of the Swiss National Supercomputing Center (CSCS) in Lugano uses a so-called distribution deck instead of a raised floor.² It houses power rails, electrical sub-distribution units and it distributes cooling water and air. Overhead air ducts are used to move hot air from the IT floor to the cooling units below. Moreover, heat exchangers and pumps have been installed on this floor as well.

The data centers of the National Renewable Energy Laboratory (NREL, Colorado) and the National Center for Atmospheric Research (NCAR, Wyoming) have a similar constructional design. Both feature a high installation floor instead of a traditional raised floor. A suspended ceiling is being used to move hot air from above the racks to the side(s) of the IT floor and from there down to the fan walls that have been installed on the installation floor. This floor is also used for power and cold water distribution. NREL also uses it for pumps and heat exchangers, while NCAR has also installed electrical transformers directly below the HPC systems. Both centers are using hot aisle containment for their air-cooled equipment, although the water-cooled HPC systems pollute the IT floor with some amount of hot air. Data center floor space is sufficient to mitigate the potentially disadvantageous effects of this.

SUMMARY

This paper presents the *Plenum* concept for data center design. Our approach argues for the construction of a full building story below the IT rooms instead of the traditional raised floor. We refer to this installation floor as *Plenum*. The most important aspect of this design is the installation of computer room air handling (CRAH) units directly beneath hot aisles, thereby requiring strictly implemented containment on the IT floor to separate hot from cold air. Among the advantages of our concept are very high air cooling energy efficiency and power density as well as natural scalability of the cooling capacity with the IT floor space. Operational benefits include the very simple layout that allows for strict separation of IT and infrastructure personnel simply based on the building stories. This is enabled by the consolidation of supply infrastructure within the *Plenum*, while the IT floor is strictly dedicated to servers, storage and networking. Moreover, the concept is characterized by a superior flexibility, as the generous *Plenum* space can be used for lots of supply infrastructure besides the CRAH units, e.g. power and cooling water distribution, pumps, heat exchangers, smoke detection systems and more. Spacious access to all infrastructure components within the *Plenum* enables easy maintenance, modifications and extensions during regular operations, thereby strongly advancing the long-term usability of data center buildings.

References

- [1] DOE. Best Practices Guide for Energy-Efficient Data Center Design. 2011.
- [2] Liam Newcombe, Mark Acton, John Booth, Sophia Flucker, Paul Latham, Steve Strutt, and Robert Tozer. 2012 Best Practices for the EU Code of Conduct on Data Centres. 2012.
- [3] Michael K Patterson, Randall Martin, J Barr von Oehsen, Jim Pepin, Yogendra Joshi, Vaibhav K Arghode, Robin Steinbrecher, and Jeff King. A Field Investigation into the Limits of High-Density Air-Cooling. Proceedings of the ASME 2013 International Technical Conference and Exhibition on Packaging and Integration of Electronic and Photonic Microsystems, 2013.
- [4] Keke Chen, Clifford C Federspiel, David M Auslander, Cullen E Bash, and Chandrakant D Patel. Control Strategies for Plenum Optimization in Raised Floor Data Centers. HP, 2006.
- [5] Kailash C Karki, Amir Radmehr, and Suhas V Patankar. Use of Computational Fluid Dynamics for Calculating Flow Rates Through Perforated Tiles in Raised-Floor Data Centers. International Journal of Heating, Ventilation, Air-Conditioning, and Refrigeration Research, 9, 2003.
- [6] Keke Chen, David M Auslander, Cullen E Bash, and Chandrakant D Patel. Local Temperature Control in Data Center Cooling: Part III, Application. HP, 2006.
- [7] James W VanGilder and Roger R Schmidt. Airflow Uniformity through Perforated Tiles in a Raised-Floor Data Center. ASME InterPACK '05, 2005.
- [8] Sukhwinder Kang, Roger Schmidt, Kanchan M Kelkar, Amir Radmehr, and Suhas V Patankar. A Methodology

² http://www.cscs.ch/uploads/tx_factsheet/20120828_Fact_Sheet_Building_English.pdf

- for the Design of Perforated Tiles in Raised Floor Data Centers Using Computational Flow Analysis. 2000 Inter Society Conference on Thermal Phenomena, 2000.
- [9] ASHRAE. 2011 Thermal Guidelines for Data Processing Environments – Expanded Data Center Classes and Usage Guidance. 2011.
- [10] ASHRAE. ASHRAE Networking Thermal Guidelines. 2013.
- [11] H. E. Khalifa and D. W. Demetriou. Energy Optimization of Air-Cooled Data Centers. *Journal of Thermal Science and Engineering Applications*, 2011.
- [12] Michael K Patterson. The effect of data center temperature on energy efficiency. In *Thermal and Thermomechanical Phenomena in Electronic Systems*, 2008. IThERM 2008. 11th Intersociety Conference on, 2008.
- [13] Michael K Patterson, Rainer Weidmann, Markus Leberecht, Manuel Mair, and Richard M Libby. An Investigation Into Cooling System Control Strategies for Data Center Airflow Containment Architectures. *InterPack 2011*, April 2011.
- [14] Michael K Patterson, Stephen W Poole, Chung-Hsing Hsu, Don Maxwell, William Tschudi, Henry Coles, David J Martinez, and Natalie Bates. TUE, a New Energy-Efficiency Metric Applied at ORNL’s Jaguar. In *Lecture Notes in Computer Science*. Springer Berlin Heidelberg, 2013.
- [15] T-Systems. *DataCenter 2020: hot aisle and cold aisle containment efficiencies reveal no significant differences*. *DataCenter 2020 White Paper*, 2011.
- [16] Chandrakant D Patel, Cullen E Bash, Christian Belady, Lennart Stahl, and Danny Sullivan. *Computational Fluid Dynamics Modeling of High Compute Density Data Centers to Assure System Inlet Air Specifications*. *IPACK’01 The Pacific Rim/ASME International Electronic Packaging Technical Conference and Exhibition*, 2001.